

Order N° \_\_\_\_\_  Quotation  
 Date \_\_\_\_\_ Signature \_\_\_\_\_  
 Customer Ref. \_\_\_\_\_ User's weight Kg \_\_\_\_\_

**PAGE 1/2**  
 2020, January

Dealer

**Key**

standard

option

**VEGA**

<b>L</b> Seat width	<input type="checkbox"/> 34 <input type="checkbox"/> 36 <input type="checkbox"/> 38 <input type="checkbox"/> 40 <input type="checkbox"/> 42 <input type="checkbox"/> 44 <input type="checkbox"/> 46 <input type="radio"/> 48
<b>P</b> Seat depth	<input type="checkbox"/> 34 <input type="checkbox"/> 36 <input type="checkbox"/> 38 <input checked="" type="checkbox"/> 40 <input type="checkbox"/> 42 <input type="checkbox"/> 44 <input type="radio"/> 46 <input type="radio"/> 48 <input type="radio"/> 50
<b>HS</b> Back-rest height	<input type="checkbox"/> 29 <input type="checkbox"/> 31 <input type="checkbox"/> 33 <input type="checkbox"/> 35 <input type="checkbox"/> 37 <input type="checkbox"/> 39 <input type="checkbox"/> 41 <input type="radio"/> 43 <input type="radio"/> 45 <input type="radio"/> 47 <input type="radio"/> 49
<b>HA</b> Front seat/floor height	<input type="checkbox"/> 42 <input type="checkbox"/> 43 <input type="checkbox"/> 44 <input type="checkbox"/> 46 <input type="checkbox"/> 48 <input checked="" type="checkbox"/> 50 <input type="checkbox"/> 52 <input type="radio"/> 54
<b>HP</b> Rear seat/floor height	<input type="checkbox"/> 38 <input type="checkbox"/> 40 <input type="checkbox"/> 42 <input type="checkbox"/> 44 <input checked="" type="checkbox"/> 46 <input type="checkbox"/> 48 <input type="checkbox"/> 50
<b>DP</b> Foot-rest/seat distance	<input type="checkbox"/> 33 <input type="checkbox"/> 35 <input type="checkbox"/> 37 <input type="checkbox"/> 39 <input type="checkbox"/> 41 <input type="checkbox"/> 43 <input type="checkbox"/> 45 <input type="checkbox"/> 47 <input type="checkbox"/> 49 <input type="checkbox"/> 51 cm

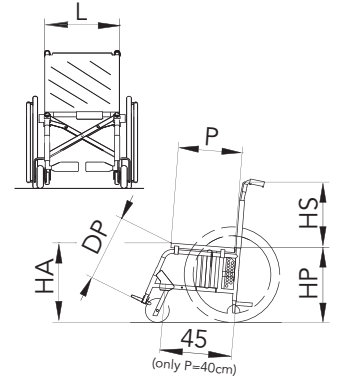

**Frame colour**

Glossy black  Pearl red  Matt black  
 Pearl white  Metallic blue  Metallic grey  
 ..... (see "Colours" catalogue)  
 Neon orange  Neon green

**Upholstery**

Tension adjustable nylon back-rest  
 Tens.adjustable breathable backrest  
 Without backrest  
 **FAMEKH** custom postural backrest  
(fill up the proper order form)

**Upholstery colour** (nylon only)

Black  
 Red  Orange  
 Light blue  Green  
 Cornflower blue

**Not detachable foot-rest**

**Detachable foot-rest**

**Elevating foot-rest (detachable)**

**Separate aluminium profile tilt adjustable foot-plates:**

forward  backward

Foot-holding belts

**Plastic separate**  
(only DP > 35 cm and L = from 38 to 46 cm)

Foot-holding belts  
 Heel stops

**Single aluminium profile tilt adjustable foot-plate:**  
(not available with detachable foot-rest)

forward  backward

Foot-holding belts

Up & outward

**Closed carbon single foot-plate**

Foot-holding belts  
 Heel stops

**Automatic closure foot-plate**  
(not available with detachable or elevating foot-rest)

Foot-holding belts

**Side guards**

Plastic

Aluminium

Carbon fibre

Plastic round cover

**Detachable Desk arm-rest - h 22 cm**

Open with side guards (only with HP > 42 cm)  
 Closed  
 27 cm high from the seat  
 Tip-up

**Elbow-rest**

Classic (23 cm long)  
 Straight (26 cm long)  
 Tubular (only with open arm-rest)  
 Hemiplegic RX  
 Hemiplegic LX

**Tip-up height adjustable from 22 to 28 cm "L" arm-rest**  
(not detachable, open with sideguards)

**Elbow-rest**

Tubular  
 Straight (26 cm long)  
 Classic (23 cm long)  
 Classic (30 cm long)

**Detachable "U" arm-rest - h 22 cm**

Open with side guards (only with HP > 42 cm)  
 Closed

Tip-up

**Elbow-rest**

Straight (26 cm long)  
 Straight (36 cm long)  
 Tubular (only with open arm-rest)  
 Hemiplegic RX  
 Hemiplegic LX

**Height adjustable arm-rest (only closed)**

Desk model  
 Sport model  
 "U" model

**Elbow-rest**

Classic (30 cm long)  
 Straight (26 cm long)  
 Hemiplegic RX  
 Hemiplegic LX  
(26 cm min. height)

Order N° \_\_\_\_\_  Quotation  
 Date \_\_\_\_\_ Signature \_\_\_\_\_  
 Customer Ref. \_\_\_\_\_

**PAGE 2/2**  
 2020, January

**VEGA**

Dealer \_\_\_\_\_

**Rear wheels** (17)

- 24" 36 spokes
- 22" 36 spokes
- 20" 36 spokes
- 12"
- 24" Ultralight 24 spokes
- 24" Spinergy
- 24" MTB Citybike
- 24" MTB Offroad
- 24" Star 6x3 18 spokes
- 24" Light 24 spokes

**Tyres**

- 24" Pneumatic Marathon Plus
- Pneum. high pressure Plugged
- Pneum. high pressure smooth
- Solid (not available with Ultralight)

**Pushrims** (18)

- Aluminium silver
- Aluminium dark
- Chromium-plated steel
- Rubber coated
- Carbolife CURVE L 24"\*
- Carbolife GEKKO 24"\*
- Silicon covers

\* not available with Star6x3 nor MTB

**Spoke guards** (19)

- Transparent
- Black
- Alphabet
- Fantasy
- code pattern: .....
- (see spokes guards catalogue)

**Front castors** (20)

- 100 (4"x1.1/4) solid with plastic rim
- 100 (4"x1) solid with lights
- 100 (4"x1.1/4) solid with alum. rim
- 125 (5"x1.1/4) solid with plastic rim
- 125 (5"x1.1/4) solid with alum. rim
- 125 (5"x1) solid with lights
- 150 (6") pneumatic
- 150 (6") solid
- 175 (7") solid
- 175 (7") pneumatic

**Rear frame** (21)

- With small wheels for narrow passages - standard

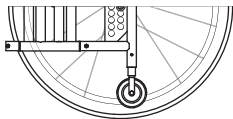

- Small wheels for narrow passages with lever

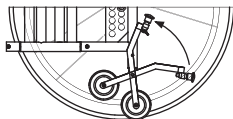

(Compulsory: rear seat/floor height HP= from 44 to 48 cm)

- Without small wheels for narrow passages

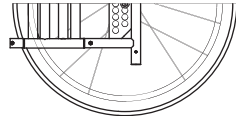

**Curved rear frame**

- without camber
- with camber

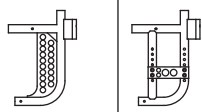

(it is not possible to assemble the small wheels for narrow passages)

**Unbalancing system** (22)

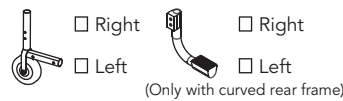

**Anti-tip device**



**Revolving anti-tip device**

(Only with curved rear frame)

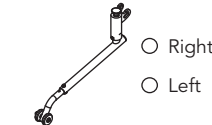

**Single drive** (23)

- Right
- Left



(Only with 0° camber)

**Extended wheel plate** (24)

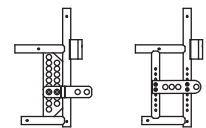

**Pushing handles** (25)

- Standard
- Hinged back-rest (without stretched bar HS>37) (with stretched bar HS>41)



- Height adjustable



**Abductor** (26)

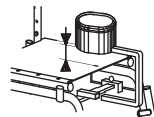

- 01
- 03
- 05
- 07 cm
- ..... cm

Choose or specify the height from seat cover

**Lateral supports** (27)

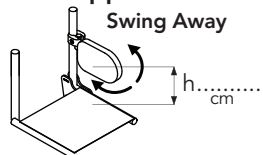

- Right
- Left

Specify the height "h"

**Table** (28)

- Transparent
- Plastic grey
- Soft padded
- RXOSX Hemiplegic transparent
- specify the fastening:
  - single
  - double



(Only with arm-rest)

**Head-rest** (29)

**Padded**

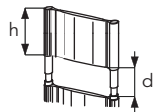

- Fixed
- Height adjustable

**Moulded**

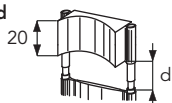

- Fixed
- Height adjustable

**Orbital**

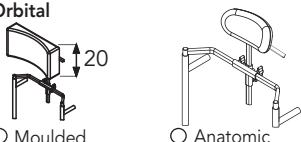

- Moulded
- Anatomic

Specify "h" & "d" where requested  
 Standard: h = 20 cm d = 15 cm  
 h = ..... cm d = ..... cm

**Lined cushion** (30)

in foam polyurethane



- 3 cm high
- 5 cm high

**Anodized set** (32)

(Light wheel rims and hubs, forks)

- Black
- Silver
- Light blue
- Red
- Orange
- Cyclamen light purple

(Only Light wheels)

**Brakes** (31)

- Classic-short handle
- Classic-pull to brake short handle
- Classic-long handle
- Scissor
- Right single brake
- Left single brake
- Drum

(To be valued on the base of the total configuration)

**Options**

- 33  "M" velcro strip (hook) on seat
- 34  "F" velcro strip (loop) on seat
- 35  Seat/back-rest connection flap
- 36  Padded rigid seat h 5 cm
- 37  Chest harness
- 38  Chest belt

**Options**

- 39  Abductor belt
- 40  WC seat
- 42  Catheter holder pocket
- 43  Stretched bar
- 44  Back anatomic board
- 45  Rx OLx Crutch holder
- 45  Rx OLx Double crutch h.
- 46  Pump for pneumatics
- 47  Suitcase holder
- 48  45° pelvic belt
- 49  45° padded pelvic belt
- 50  Black backpack
- 52  Umbrella holder

**Notes**

-----  
 -----  
 -----  
 -----  
 -----