

Dealer _____

Key

standard

option

L Seat width	<input type="checkbox"/> 34 <input type="checkbox"/> 36 <input type="checkbox"/> 38 <input type="checkbox"/> 40 <input type="checkbox"/> 42 <input type="checkbox"/> 44 <input type="radio"/> 46 <input type="radio"/> 48	
P Seat depth	<input type="checkbox"/> 36 <input type="checkbox"/> 38 <input checked="" type="checkbox"/> 40 <input type="checkbox"/> 42 <input type="radio"/> 44 <input type="radio"/> 46 <input type="radio"/> 48 <input type="radio"/> 50	
HS Back-rest height	<input type="checkbox"/> 29 <input type="checkbox"/> 31 <input type="checkbox"/> 33 <input type="checkbox"/> 35 <input type="checkbox"/> 37 <input type="checkbox"/> 39 <input type="checkbox"/> 41 <input type="radio"/> 43 <input type="radio"/> 45 <input type="radio"/> 47 <input type="radio"/> 49 <input type="radio"/> 51	
HA Front seat/floor height	<input type="checkbox"/> 42 <input type="checkbox"/> 43 <input type="checkbox"/> 44 <input type="checkbox"/> 46 <input type="checkbox"/> 48 <input checked="" type="checkbox"/> 50 <input type="checkbox"/> 52 <input type="radio"/> 54	
HP Rear seat/floor height	<input type="checkbox"/> 38 <input type="checkbox"/> 40 <input type="checkbox"/> 42 <input type="checkbox"/> 44 <input checked="" type="checkbox"/> 46 <input type="checkbox"/> 48 <input type="checkbox"/> 50	
DP Foot-rest/seat distance	<input type="checkbox"/> 33 <input type="checkbox"/> 35 <input type="checkbox"/> 37 <input type="checkbox"/> 39 <input type="checkbox"/> 41 <input type="checkbox"/> 43 <input type="checkbox"/> 45 <input type="checkbox"/> 47 <input type="checkbox"/> 49 <input type="checkbox"/> 51	cm

MINISTAR PREMIUM

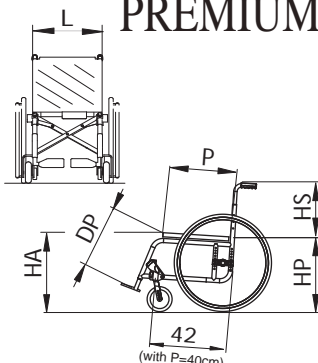

Frame colour

- Metallic blue Pear red Metallic grey
 Glossy black Metallic light blue
 Orange Cyclamen light purple Pear white
 (see "Colours" catalogue)

①

Upholstery

- Tension adj. nylon back-rest
 Tension adj. breathable back-r.
 Without back-rest
 Without seat

②

Upholstery colour

(only nylon)

- Black
 Red Orange
 Light blue Green
 Cornflower blue

③

Not detachable foot-rest

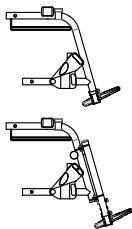

Detachable foot-rest

④

Separate aluminium profile tilt adjustable foot-plates:

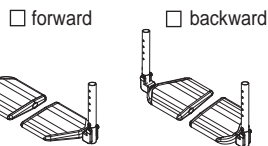

Foot-holding belts

⑤

Single aluminium profile tilt adjustable foot-plate:

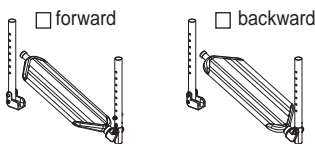

Foot-holding belts

⑥

Automatic closure foot-plate

(not available with detachable foot-rest; only L= from 36 to 46 cm)

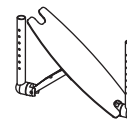

Foot-holding belts

⑦

Side guards

⑨

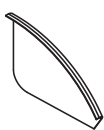
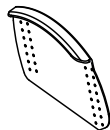

- Plastic Aluminium same colour Carbon fibre

Detachable Sport arm-rest - h 22 cm

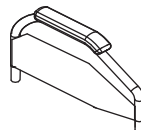

- Open with side guards (only with HP > 42 cm)
 Closed
 27 cm high from seat
 Tip-up

Elbow-rest

- Classic (23 cm long)
 Straight (26 cm long)
 Tubular
 Hemiplegic RX
 Hemiplegic LX

⑩

Height adjustable arm-rest

(only with aluminium side guards) (only L from 34 to 44 cm)

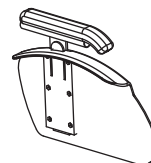

Elbow-rest

- Classic (23 cm long)
 Classic (30 cm long)
 Straight (26 cm long)

⑪

Rear wheels

⑫

- 24" 36 straight spokes
 22" 36 str. spokes 20" 36 straight spokes
 24" Light 24 spokes
 24" Ultralight 24 spokes
 24" Mountain-bike (Citybike tyre)
 24" Mountain-bike (Offroad tyre)

Tyres

- Pneum. high press.Plugged
 Pneum. high press.Smooth
 Solid
 24" Pneum. Marathon Plus

Handrims

⑬

- Chromium-plated steel
 Aluminium silver
 Aluminium dark
 Rubber coated
 Tween Greep (only 24" & 22")
 Max Grepp
 Max Grepp Ergo (*)
 Silicon covers

(*) Not available with Mountain-bike wheels

Spoke guards

⑭

- Transparent
 White
 Black
 Multicolour
 Black plumed red
 Black plumed blue
 Black plumed green
 Alphabet

Front castors

⑮

- 100 (4"x1.1/4) solid with plastic rim
 100 (4"x1) solid with lights
 100 (4"x1) solid with aluminium rim
 100 (4"x1.1/4) solid with alum. rim
 125 (5"x1.1/4) solid with plastic rim
 125 (5"x1) solid with aluminium rim
 125 (5"x1.1/4) solid with alum. rim
 150 (6") pneumatic
 150 (6") solid
 175 (7") solid
 175 (7") pneumatic

Dealer _____

Distance between the hub centre and the back-rest (16)

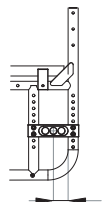

- 2 cm
 4 cm (standard)
 6 cm

Curved rear frame (standard) (18)

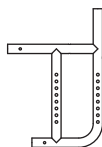

Unbalancing system



- Right
 Left

Revolving anti-tip device



- Right
 Left

The unbalancing system and the revolving anti-tip device can not be chosen on the same side

Single drive (19)

- Right
 Left



Rear wheel camber (17)

- 0° 1° 2°
 3° 4°

Extended wheel plate (20)

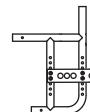

Pushing handles (21)

- Standard
 Hinged back-rest (without stretched bar HS > 37) (with stretched bar HS > 43)
 Height adjustable (max L = 48 cm)

Brakes (22)

- Classic - short handle
 Classic - long handle

Anodized set (23)

(Rear wheel rims, rear wheel plate and forks: 36 spoke wheels)
(Rear wheel rims&hubs, rear wheel plate and forks: Light wheels)

- Black
 Silver
 Light blue
 Lime Green
 Red
 Orange
 Cynamlan light purple

Lined cushion in foam polyurethane (24)



- 3 cm high
 5 cm high

Options

- 25 "M" velcro strip (hook) on seat
 26 "F" velcro strip (loop) on seat
 27 Seat/back-rest connection flap
 28 Padded rigid seat
 29 Chest harness
 30 Chest belt
 31 Abductor belt
 32 Double cross bar
 33 Stretched bar
 34 Catheter holder pocket

Options

- 35 Back anatomic board
 36 Rx Lx Crutch holder
 37 Pump for pneumatics
 38 Suitcase holder
 39 45° pelvic belt
 40 45° padded pelvic belt
 41 Black holdall
 43 Umbrella holder

Notes